

OWNER'S GUIDE

Pharmacy, Laboratory, & Chromatography Glass Door(s) Refrigerator or Freezer with Touch Screen Alarm System & Microprocessor Temp Control V5.2

Table of Contents

RECEIVING AND SHIPPING DAMAGE HANDLING	2
SAFETY	3
RELEASE OF LIABILITY	3
ELECTRICAL INFORMATION	4
UNPACKING.....	5
INSTALLATION	7
OPERATION	9
Quick Troubleshooting Guide	31
Maintenance and Cleaning	34
Hydrocarbon Service Notes	36
Factory Warranty Policy	37

RECEIVING AND SHIPPING DAMAGE HANDLING

Each refrigerator or freezer is carefully inspected to meet our high standard quality assurance policy, before it ships to you. Unfortunately, shipping damage can happen during transportation to you. There are two general types of shipping damage. The first is **visible damage**. This type of damage includes visible loss, damage, shortage or any external evidence of loss or damage that is visible at time of delivery. **This type of damage must be noted in detail on your delivery receipt. Make sure the driver signs and dates the delivery receipt, acknowledging the damages. We also recommend to take many pictures to demonstrate and document the damaged area(s).** This has to happen at the time of delivery or it won't happen at all. Keep a copy for your records and send another to the carrier's damage claims department along with a formal request for an inspection report. Follow up with a phone call. Their contact information can be found on the carrier's web site.

The second type of shipping damage is **concealed damage**. This type of damage will probably not be apparent at time of delivery and may not be discovered until unpacking and inspecting the unit. Remember, time is of the essence here. You should unpack and inspect the unit as soon as possible. Each day that passes reduces the likelihood that the carrier will pay the claim. **As soon as the concealed damage is discovered, stop unpacking and retain all packing materials. Take many pictures to demonstrate and document the concealed damage area(s). Contact the carrier by phone to report the claim.** Note the date and time and person you spoke with. Get a claim number. Follow up with a written letter referencing the claim number and including a formal request for an inspection. Again, consult the carrier's website for specific claim instructions and follow them precisely.



AS STATED ABOVE, THE CARRIER IS YOUR SOLE SOURCE FOR SATISFACTION OF A DAMAGE CLAIM. UNDER NO CIRCUMSTANCES SHOULD THE MERCHANDISE BE RETURNED TO THE MANUFACTURER. NO RETURNS WILL BE ACCEPTED WITHOUT PRIOR AUTHORIZATION.

SAFETY



For your safety

- DO NOT store any unsealed chemical material in this refrigerator or freezer. Corrosive fumes from chemical material can linger inside of the chamber, and cause serious damage to the refrigeration coils. Storing unsealed chemical material in this equipment will void the factory product warranty.
- DO NOT store or use gasoline, or other flammable liquid in this refrigerator or freezer. This equipment is not rated to be a flammable material storage.
- DO NOT operate this equipment in the presence of explosive fumes. This equipment is not rated to be a hazardous locations refrigerator or freezer.

We offer flammable material storage and hazardous locations refrigerators and/or freezers for your application. Please contact your local sale representative for more information.

RELEASE OF LIABILITY



Before you start to use this refrigerator, please take a moment to:

- Connect your remote alarm contacts system, or auto dialer, to the refrigerator's alarm system (if any).
- If your refrigerator model does not have an alarm system, you can install your 3rd party alarm into our refrigerator via the 3/8" access porthole. Please see "Field Monitor Probe Installation" Section.
- Develop an emergency backup plan, and designate a different refrigerator or freezer to store the contents, if this refrigerator has an unforeseen issue.

IF YOU PLAN TO STORE IRREPLACEABLE AND/OR HIGH VALUE PRODUCTS IN THIS UNIT TAKE THE PROPER PRECAUTIONS NOW.

The manufacturer's sole obligation under this warranty is limited to either repair or replacement of parts, subject to the additional limitations below. This warranty neither assumes, nor authorizes any person to assume obligations other than those expressly covered by this warranty.

NO CONSEQUENTIAL DAMAGES. The manufacturer is not responsible for economic loss, profit loss, or special indirect or consequential damages, including without limitation, losses, or damages arising from contents spoilage claims whether or not on account of refrigeration or mechanical failure.

ELECTRICAL INFORMATION

- The supply circuit to this cabinet must conform to NEC (National Electrical Code). Consult the cabinet Serial-Data plate for voltage, cycle, phase, and amp requirements before making connection.
- SUPPLY VOLTAGE SHOULD NOT VARY MORE THAN 5% FROM SERIAL PLATE RATINGS.
- DO NOT connect this equipment to a GFI (Ground Fault Interrupt) circuit.
- **Do not use an extension cord or any multi-outlet strip or plug.** Using such devices can lead to insufficient power, and lead to component failure, such as the compressor or starting components.
- If the power cord is damaged, it should be replaced immediately by an authorized service technician.

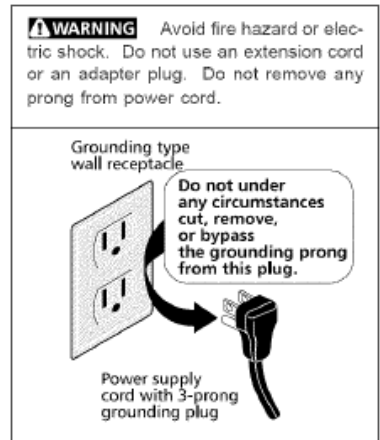

Be sure your unit is properly grounded. Use the 3-prong plug provided into a 3-prong grounded outlet. Unless the above grounding method is followed, you are not protected against severe or lethal shock in the event of a short circuit of an electrical component or wiring of the unit.

UNPACKING

This section will show you the shipping materials in this refrigerator that need to be removed and discarded. Please note, your installer may have done it for you. However, it is always recommended to check the following items.

 If a refrigerator is not unpacked fully, it may affect its operation in the future. For example, a refrigerator still sits on its wooden shipping pallet after a few months of use.

REQUIRED TOOLS – 9/16" socket or wrench, 3/4" open end wrench, Phillips head screwdriver, and level.

Move your refrigerator as close to the final location as possible before removing the wooden skid. The location should be as close as possible to the power outlet.

Remove the lower grill assembly from the front of cabinet.

Skid bolts are located in each of 4 corners inside cabinet bottom. (See photo A). Remove skid bolts. (See photo B). Carefully lift cabinet off of skid. Replace the lower grill assembly back onto the refrigerator.



Swing Door Models – Remove door support bracket on interior bottom of the swing glass door and discard (see Image 1 & 2).

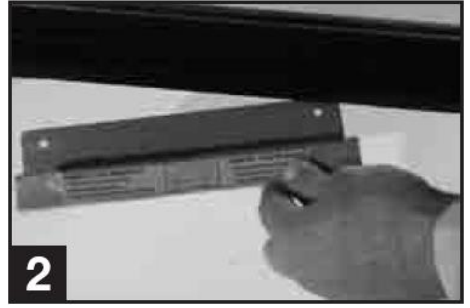
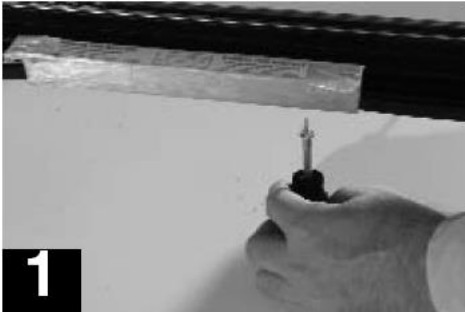

Sliding Doors Models – Remove the Styrofoam blocks on the top of the door tracks (see Image 3) and the plastic door stoppers (see Image 4, 5, and 6)



INSTALLATION

Please take a moment to follow the steps below, before using this equipment.

1. Find a suitable location to install this refrigerator (or freezer)
2. Level this refrigerator (or freezer)
3. Set up the shelves inside (if applicable)
4. Install the optional monitor probe for field installation
5. Ready to use

1. SUITABLE LOCATION

Ambient Temperature – Unlike a household refrigerator, this equipment is designed for scientific / medical application. Many components are heavy duty and extra sized, in order to meet the ultimate temperature performance. Therefore, the sounds generated from its operation may not be accepted by everyone in the room. Please take the operation sound factor into consideration, and locate this refrigerator accordingly.

Please ensure the ambient temperature is climate-controlled, between 65°F to 85°F, in order to achieve the ultimate temperature performance.

Clearance Space – We require 2 to 3 inches of clearance space around the refrigerator. So it would be easier to remove the refrigerator for annual maintenance, or service.

2. LEVELING

Once this refrigerator or freezer is at its final location, please level your refrigerator, because it is critical to equipment operation. Here are a few benefits to a good leveled refrigerator (or freezer):

1. Moving mechanical parts, such as fan or compressor, would have less chances to fail, since it is in the designed upright position.
2. Reduce noise.
3. Door(s) would close properly.
4. Condensate water would flow out the refrigerator properly.

To level this equipment, set a leveler in each corner on the top. If the equipment is not level, adjust either the leveling legs or casters.



We recommend to slightly tilt the refrigerator (or freezer) toward to the back, about 5 degrees. So the non-self-closing door can be shut properly, and condensate water would flow out easier.

3. (OPTIONAL) MONITOR PROBE FOR FIELD INSTALLATION

Each refrigerator or freezer is equipped with a 3/8" probe access port hole for your independent probe installation. The port hole is generally located in the back of your refrigerator (or freezer). Simply remove the white caps, run your probe through, and seal the hole with electrical putty to prevent air from getting into the chamber.



DO NOT run your probe through the door gasket, as it may cause serious condensation or a frozen evaporator issue. The port hole is specifically designed to allow you to install the monitor probe.

4. READY TO USE

Once you ensure the electrical service is adequate and Steps 1 to 3 are followed, you are ready to use this refrigerator (or freezer). Simply plug in the power cord into the wall outlet.

This refrigerator (or freezer) is factory set to run at its ultimate temperature performance. There should not be a need to adjust the temp settings. If you feel the temp settings must be adjusted, please refer to "TEMPERATURE ADJUSTMENT" section in this manual for more details.

OPERATION



Upon receiving the refrigerator or freezer, please take a moment to activate the battery to the Touch Screen display alarm system. The battery supports the touch screen alarm operation during a power failure event. This is an important step. See the following information on the battery backup alarm function.



DO NOT use any sharp or pointed object to operate the touch screen. To clean the screen, only use lens cleaning wipes or microfiber cloth. Any scratch to the screen is not covered under warranty.

INTRODUCTION

The Touch Screen display and alarm system is designed to display the refrigerator's interior sample temperature, and give alarms if an error occurs. In addition, the system logs the temp readout every 60 seconds and stores up to 1 year of data. Once the data is full, the newest data overwrites the oldest data.

FEATURES

- Sample temperature display
- Decimal temperature readout
- Battery backup for power failure
- Single point HI and LO temp history
- Temperature calibration (offset)
- °C/°F readout switch
- Real world time clock display
- Temp chart (24 hours)
- Visual temp scale bar
- Tech support info (QR code)
- Password protection
- Data logging
- Data download (via USB cable)
- Visual Alarm
- Audible Alarm
- Remote Alarm
- High temp alarm
- Low temp alarm
- Power failure alarm
- Sensor error alarm
- Low battery alarm
- Audible alarm volume
- Audible alarm ring back
- Door alarm
- 4-20mA output
- Alarm validation

MAIN SCREEN

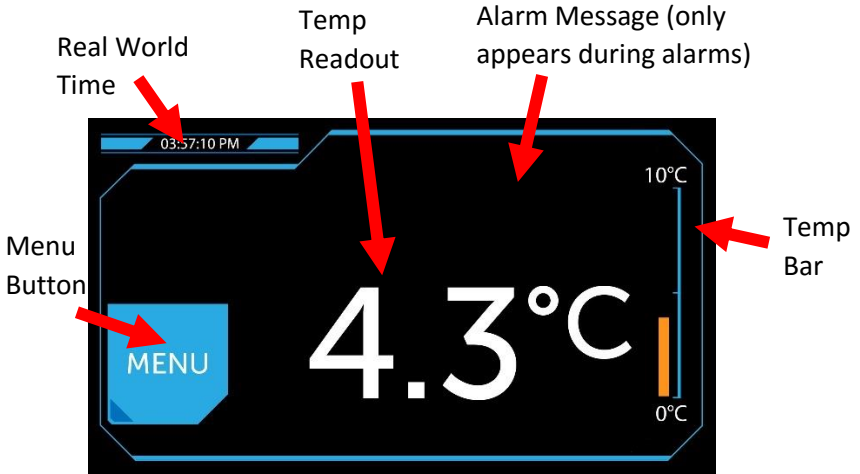

*Your touch screen display layout may look slightly different from the illustration above, but the information is the same.

BATTERY BACKUP & POWER FAILURE ALARM

The Touch Screen display alarm system uses a rechargeable battery. During a power failure the batteries will support the data logging, the alarm system, and the temperature display for 8 hours. When the power resumes, the batteries will be automatically recharged, and the display will return to the normal operation.

During a power failure event, the visual display will display “power failure” message, and will instruct to check the main power source. Audible alarm & remote alarm contact would be activated to alert users. The Touch Screen display will still display and log the refrigerator temperature during a power failure event until the battery power is depleted.

MENU

The features under [MENU] will allow you access useful information, and also allow you to change many settings.

Function	Description
CHART	Last 24 hours temp recording in a line format.
LOG	Numbers of data recorded.
MIN/MAX	1-point maximum and minimum temp record. Press [RESET] to clear the history.
SUPPORT	Tech Support contact information and QR code link to download manuals.
TEST	Press [TEST] to set off visual, audible, and remote alarm contact to validate the alarms are working.
SETTING	Enter password (factory: 0,0,0,0) to change the following settings: °C/°F Change the display scale between °C or °F HI/LO Change the high & low temp alarm point OFFSET Change the display readout offset. TIME Change the display time zone. VOLUME Change the audible alarm volume. RINGBACK DELAY Change the audible alarm reminder. REMOTE DELAY Change the remote alarm delay. DOOR DELAY Change the door alarm delay. USERS Change the password code.

CHECK 1-POINT TEMPERATURE HISTORY

Your facility policy may require to record this refrigerator's maximum and minimum temperature point within last 24 hours. Press [MENU] -> [MIN/MAX] to check the 1-point temp history record. Press [RESET] to clear the history.

TECH SUPPORT INFORMATION

A QR code will allow you to locate Technical Support Info. In addition, the display shows our technical service department contact phone number.

ALARM TEST (VALIDATION)

Your facility may require you to validate the alarm function. This feature will allow you to manually set off visual, audible, and remote alarm, without intentionally warming up the refrigerator. Press [MENU] -> [TEST] to enter the alarm validation. Press [TEST] button. The alarms will be activated for 5 seconds.

CHANGE TEMPERATURE READOUT BETWEEN °C AND °F

You are able to change the display units between °C AND °F. Press [MENU] -> [SETTING] and enter your password, and choose [C/F] to change the temp units. Please note, the logging data will only be available in Celsius format.

CALIBRATION / OFFSET (OFF)

Before making an OFFSET change, please note that this procedure should only be carried out by a certified technician with a NIST traceable calibrated thermometer.

This feature allows a user to change the temperature reading with +/- 5 degree differences.

For example, if a technician's NIST traceable calibrated thermometer is reading 5C, while the display reads 3C, make a +2C change in offset setting.

TIME

This setting allows you to change the time zone on the Real World Time on the main screen. The factory setting is Eastern Time.

VOLUME

This setting allows you to change the audible alarm volume. If this refrigerator is placed in a room filled with other equipment, you may want to turn up the volume in order to be able to hear the audible alarm.

HIGH TEMP ALARM POINT (ALU)

Under this function, you are able to change the high temperature alarm point. Once the refrigerator temperature reaches the set point, the display will show "HIGH TEMP ALARM!" message. Press [MENU] -> [SETTING] and enter your password, and choose [HI/LO] to change the high temp alarm point.

LOW TEMP ALARM POINT (ALL)

Under this function, you are able to change the low temperature alarm point. Once the refrigerator temperature reaches the set point, the display will show "LOW TEMP ALARM!" message. Press [MENU] -> [SETTING] and enter your password, and choose [HI/LO] to change the low temp alarm point.

RING BACK DELAY

Ring back delay is an audible alarm “snooze” feature. You are able to silent the audible alarm for a period of time (ring back delay setting), before the audible alarm returns to remind you the refrigerator’s error condition.

REMOTE ALARM DELAY

It is a time delay after the visual and audible alarm being activated. It gives users some time to correct an error, before sending the alarm to the remote monitor system.

For example, the delay is set to be 20 (minutes). A user forgets to close the refrigerator’s door, and the temperature warms up to 10C. The High Temp visual and audible alarm will be activated. If the temperature continues to stay above High Temp, 20 minutes later the remote alarm will be activated.

Please note, Remote Alarm will be immediately activated during a power failure event. It would be deactivated when the power resumes and the temperature returns to normal.

REMOTE ALARM SYSTEM (SPST RELAY)

It is recommended to contact your facility manager, or a local technician to assist you in connecting the remote alarm system.

This touch screen display’s remote alarm system is wired to be gray and white leads. It is located at either 1) underneath of top sign canopy, or 2) behind the unit, next to the compressor.

During non-alarm state, the remote alarm system is at CLOSED position (NC). During an alarm state, the system is at OPEN position.

Rating: 3 amps.

DOOR DELAY

This setting allows you to change the door ajar alarm duration. If you set to 1 minute, the DOOR ALARM will be activated once the refrigerator’s door is opened for over a minute.

USERS

This setting allows you to change the password to your own. If you forget the password, please contact our Technical Service Department.

4-20mA REMOTE MONITOR

The Touch Screen Display, provides a 4-20 ma current sink on pins 1 (Input) and 2 (Output). The indicating element(s) may be loop-powered as well, as long as the net voltage across the output exceeds 3V d.c. but is less than 90V d.c.

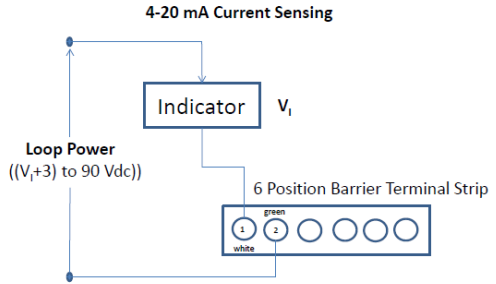

The transmitter may be connected anywhere in the loop. A typical installation would be a 15V supply driving one indicator and the Touch Screen Display. The AP may be connected before or after the indicator in circuit so you can use indicators, whose negative loop connection (loop return) can be at the same potential as their power supply ground if they are not loop-powered.

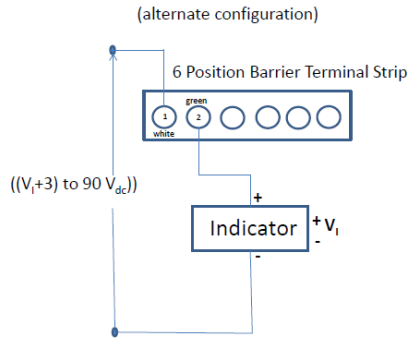

Circuit recommendations.

Resolution:-	0.06mA
Accuracy:-	+/- 2%
Minimum supply voltage	3V + Indicator compliance (VI)*
Maximum supply voltage	90V

*The AP board needs a minimum of 3V to operate and this plus the maximum operating voltage (compliance) of the indicator will determine the minimum power supply voltage. For example, if the indicator can take up to 6V, then the minimum power supply voltage will be 3+6 = 9V.

DATA LOGGING

Before starting to use the data logging feature, please take a moment to read through the following instruction.

The logger is programmed to record the temperature every 60 seconds. It can store up to 365 days data. Once the data storage is full, the newest data will overwrite the oldest data.

Computer System Specification: Windows XP, 7, and 10, home or professional edition.

INSTALLATION –

1. Insert the USB drive (included in the package) to your computer. Follow the instruction to install the logging program on your computer. It may take a few minutes to complete the installation. (Default Location: HorizonScientific -> DeviceUtility -> DisplayDevice_Utility.exe)

OPERATION –

2. Connect the USB cable (included in the package) to the display and to your computer.
3. Start the logging program on your desktop shortcut. You should see the logger on the program selection. If not, close out the program and restart it again, and check the USB cable connection.
4. Click [MENU] icon. Select [Retrieve Device Logged Data].

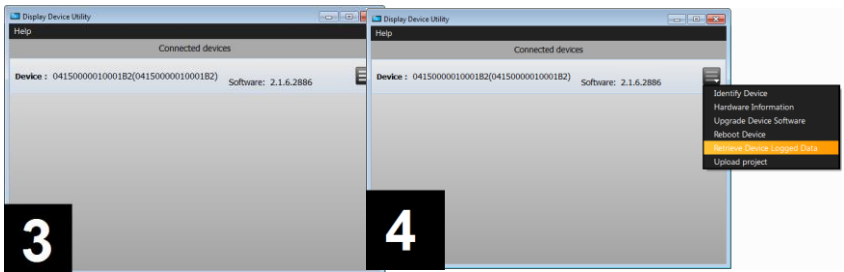

5. The program will automatically retrieve the data from the display. Please note, it may take a moment to download the data. At this moment, you

will also see the data is being downloaded from the progress bar on the touch screen display.

6. Once the data is downloaded, a selection window pops up to allow you choose either a) last 24 hours data (log_day), or all data (log_30day). Select the data you would like to download, and select the file folder location to be saved. Press [DOWNLOAD] button to confirm.

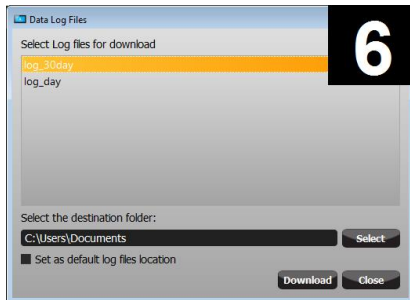
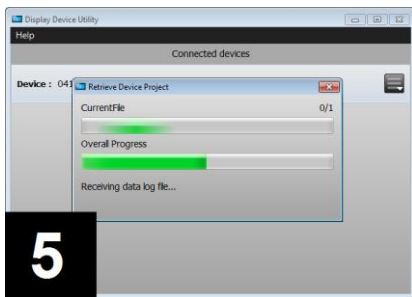

7. Once the data is downloaded into your computer, a window will pop up to ask you to whether keep the data in the display, or delete the data from the display. Please note! Once you select [DELETE FILES], the data will be erased from the display.
8. Press [CLOSE] to exit out the logger program.

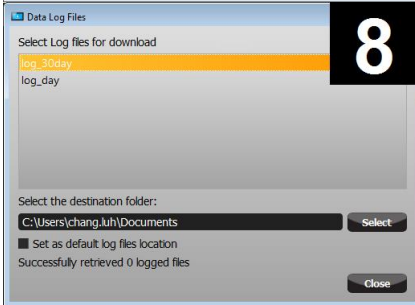
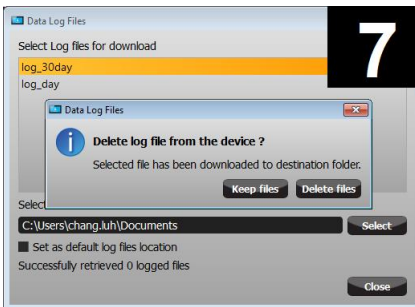

9. The downloaded data is saved as Excel file format. Locate the file in the folder. Open it with Microsoft Excel.

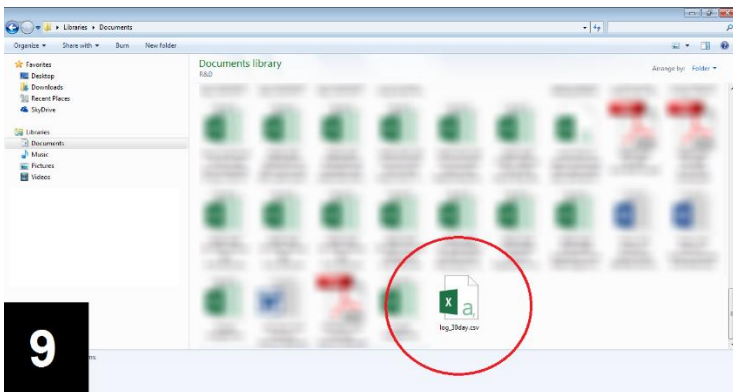

10. Double-click the line between B and C column, in order to extend the B column width. Now you are able to see the entire date and time. You may plot the data into a temp chart via Excel's Chart feature. Please note, the data is saved in Celsius format.

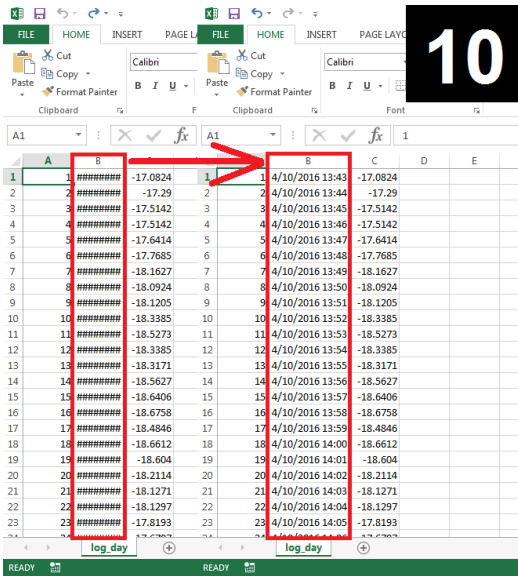

If you have any concern or question, please contact our Technical Service Department for assistance. 1-(800)-648-4041 ext. 4.

Temperature Controller System

Product Description

The digital microprocessor temperature controller is designed to provide temperature control of refrigerators or freezers. The controller also provides a constant readout of the sample temperature inside of the unit. A touch keypad allows the user to easily select the display units, set point, and differential set point.

 **Please Note: The digital temperature controller has been factory set and tested to allow your unit to operate at its desired temperature cycle.**

Adjusting the settings on the controller will alter these factory settings. WE STRONGLY RECOMMEND YOU CONTACT THE MANUFACTURER'S TECHNICAL SUPPORT DEPARTMENT BEFORE MAKING ANY ADJUSTMENTS TO THIS CONTROLLER. TECH SUPPORT PHONE NUMBER IS (800) 648 4041 Option 4



CHECK TEMPERATURE HISTORY

Press and release [UP] button. The display will show the maximum temperature ever reached since the last reset.

Press and release [DOWN] button. The display will show the minimum temperature ever reached since the last reset.

Press and hold [SET] for more than 3 seconds, while the maximum or minimum temp is displayed. (rSt message will be displayed).

CHECK THE SET POINT

Press and release [SET] button. The display will show the current set point value.

Operation

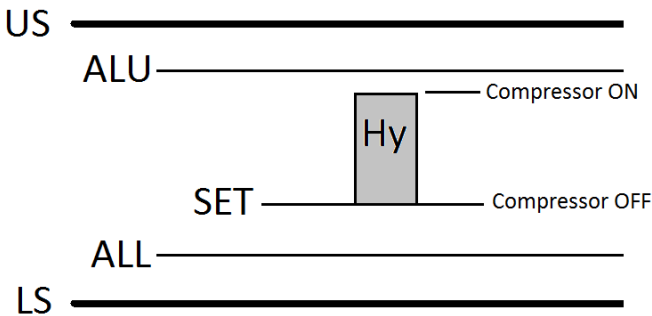

During the normal operation, the refrigerator's (or freezer's) compressor would turn on and off, in order to maintain the cold temperature in the storage chamber.

In this controller, the point where the compressor is cut off is called "SET POINT". The point where the compressor is turned on is calculated by adding the value of "SET POINT" and "Hy" (temp differential).

For example, if you wish to maintain the operation temperature between 3°C and 7°C, you would set "SET" = 3°C, and "Hy" = 4°C.

"ALU" is the high temp alarm point, and "ALL" is the low temp alarm point. Both alarm settings will alert users when the refrigerator's (or freezer's) temp is out of range, via visual & audible alarm, and remote alarm contact.

"US" is the upper setting limit, and "LS" is the lower setting limit. Both limit settings will prevent users accidentally adjust "SET", "ALU", or "ALL" outside the range.

CODE	DESCRIPTION	FACTORY SETTING
SET	Temp set point (compressor off point)	3°C or 38°F (refrigerator) -24°C or -12°F (freezer)
Hy	Temp differential between compressor start and off point	3°C or 5°F (NOT RECOMMENDED TO CHANGE)
ALL	Low temp alarm point	1°C or 34°F (refrigerator) -28°C or -18°F (freezer)
ALU	High temp alarm point	10°C or 50°F (refrigerator) -15°C or 5°F (freezer)
Lod	Screen display choice (air or sample probe)	P3
CF	Celsius & Fahrenheit unit change	
O3	Sample (display) probe calibration / offset	0
OT	Air (control) probe calibration / offset	0
US	The maximum limit that SET or ALU could reach	10°C or 50°F (refrigerator) -10°C or 14°F (freezer)
LS	The minimum limit that SET or ALL could reach	1°C or 34°F (refrigerator) -30°C or -22°F (freezer)

Change the set point (compressor turn-off point)

Press and hold [SET] until °C or °F icon blinking. Press [UP] or [DOWN] to change the setting value. Then, press [SET] once to confirm the new setting.

Change the other settings

Press and hold both [SET] and [DOWN] at the same time until “Hy” appears on the display.

Press [UP] or [DOWN] to scroll different settings. Press [SET] to enter the setting. Press [UP] or [DOWN] to change value. Press [SET] once to confirm the new setting. The display will show the next setting.

At any setting, press and hold both [SET] and [UP] to exit out the setting mode, or simply leave the display alone for 10 seconds.

Change the readout from °C to °F, or °F to °C

Press and hold the [LIGHT] icon button for 5 seconds. The controller will restart and change the display scale from °C to °F, or °F to °C.

Advanced Settings – for service technician only

 **ATTENTION: This section is for service technicians or experienced users only. Altering the following settings can result in malfunction or inaccurate temperature readout.**

Air and Sample Temperature Display

The controller has the capability to display either the air or sample temperature readout. For the normal operation, the sample-simulated temperature (P3) is displayed in order to provide users the content temperature. For the actual operation, the air temperature (P1) is used to control the compressor's cycle.

This is a useful tool for you to make a precise adjustment, or temperature validation process.

“Lod” setting allows you to display either air (P1) or sample (P3). Press and hold both [SET] and [DOWN] at the same time until “Hy” appears on the display.

Press [UP] or [DOWN] until “Lod” shows up. Press [SET] to enter the setting. Press [UP] or [DOWN] to toggle between the air temp “P1”, or the sample temp “P3”. Press [SET] once to confirm the new setting. The display will now show the temp you have selected.

 **We strongly recommend you to change the “Lod” setting back to “P3” before you complete the service. This will allow users to see the sample-simulated temperature, and the controller will be able to alert when the sample temp is out of range.**

Calibration / offset

“OT” setting allows you to change the air probe's calibration. “O3” setting allows you to change the sample probe's calibration.

Please be sure you have a NIST traceable and calibrated thermometer. Place your thermometer's probe next to our sensor accordingly, air vs. air, or sample vs. sample, before making an adjustment on either “OT” or “O3”.

For more advanced settings, please contact our Technical Service Department for assistance. (800) 648 4041 Option 4

Temperature Controller System

Product Description

The digital microprocessor temperature controller is designed to provide temperature control of refrigerators or freezers. The controller also provides a constant readout of the sample temperature inside of the unit. A touch keypad allows the user to easily select the display units, set point, and differential set point.

 **Please Note: The digital temperature controller has been factory set and tested to allow your unit to operate at its desired temperature cycle.**

Adjusting the settings on the controller will alter these factory settings. WE STRONGLY RECOMMEND YOU CONTACT THE MANUFACTURER’S TECHNICAL SUPPORT DEPARTMENT BEFORE MAKING ANY ADJUSTMENTS TO THIS CONTROLLER. TECH SUPPORT PHONE NUMBER IS (800) 648 4041 Option 4

One of two controller types is installed in your refrigerator. Before operating the controller, please take a moment to identify which controller your refrigerator is equipped. The following pages will show you both controllers’ operation in section.

VERSION ONE



VERSION TWO



VERSION ONE



CHECK TEMPERATURE HISTORY

Press and release [UP] button. The display will show the maximum temperature ever reached since the last reset.

Press and release [DOWN] button. The display will show the minimum temperature ever reached since the last reset.

Press and hold [SET] for more than 3 seconds, while the maximum or minimum temp is displayed. (rSt message will be displayed).

CHECK THE SET POINT

Press and release [SET] button. The display will show the current set point value.

Operation

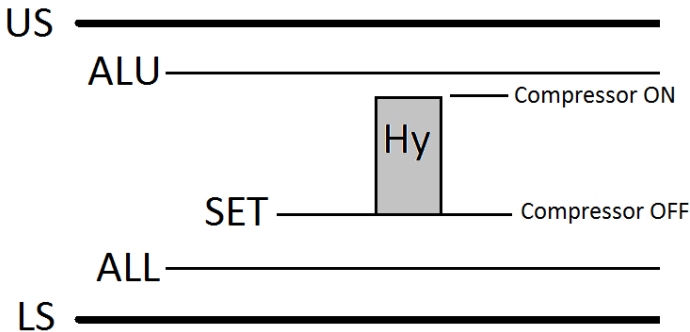

During the normal operation, the refrigerator's (or freezer's) compressor would turn on and off, in order to maintain the cold temperature in the storage chamber.

In this controller, the point where the compressor is cut off is called “SET POINT”. The point where the compressor is turned on is calculated by adding the value of “SET POINT” and “Hy” (temp differential).

For example, if you wish to maintain the operation temperature between 3°C and 7°C, you would set “SET” = 3°C, and “Hy” = 4°C.

“ALU” is the high temp alarm point, and “ALL” is the low temp alarm point. Both alarm settings will alert users when the refrigerator’s (or freezer’s) temp is out of range, via visual & audible alarm, and remote alarm contact.

“US” is the upper setting limit, and “LS” is the lower setting limit. Both limit settings will prevent users accidentally adjust “SET”, “ALU”, or “ALL” outside the range.

CODE	DESCRIPTION	FACTORY SETTING
SET	Temp set point (compressor off point)	3°C or 38°F (refrigerator) -24°C or -12°F (freezer)
Hy	Temp differential between compressor start and off point	3°C or 5°F (NOT RECOMMENDED TO CHANGE)
ALL	Low temp alarm point	1°C or 34°F (refrigerator) -28°C or -18°F (freezer)
ALU	High temp alarm point	10°C or 50°F (refrigerator) -15°C or 5°F (freezer)
Lod	Screen display choice (air or sample probe)	P3
CF	Celsius & Fahrenheit unit change	
O3	Sample (display) probe calibration / offset	0
OT	Air (control) probe calibration / offset	0
US	The maximum limit that SET or ALU could reach	10°C or 50°F (refrigerator) -10°C or 14°F (freezer)
LS	The minimum limit that SET or ALL could reach	1°C or 34°F (refrigerator) -30°C or -22°F (freezer)

Change the set point (compressor turn-off point)

Press and hold [SET] until °C or °F icon blinking. Press [UP] or [DOWN] to change the setting value. Then, press [SET] once to confirm the new setting.

Change the other settings

Press and hold both [SET] and [DOWN] at the same time until “Hy” appears on the display.

Press [UP] or [DOWN] to scroll different settings. Press [SET] to enter the setting. Press [UP] or [DOWN] to change value. Press [SET] once to confirm the new setting. The display will show the next setting.

At any setting, press and hold both [SET] and [UP] to exit out the setting mode, or simply leave the display alone for 10 seconds.

Change the readout from °C to °F, or °F to °C

Press and hold the [LIGHT] icon button for 5 seconds. The controller will restart and change the display scale from °C to °F, or °F to °C.

Advanced Settings – for service technician only



ATTENTION: This section is for service technicians or experienced users only. Altering the following settings can result in malfunction or inaccurate temperature readout.

Air and Sample Temperature Display

The controller has the capability to display either the air or sample temperature readout. For the normal operation, the sample-simulated temperature (P3) is displayed in order to provide users the content temperature. For the actual operation, the air temperature (P1) is used to control the compressor’s cycle.

This is a useful tool for you to make a precise adjustment, or temperature validation process.

“Lod” setting allows you to display either air (P1) or sample (P3). Press and hold both [SET] and [DOWN] at the same time until “Hy” appears on the display.

Press [UP] or [DOWN] until “Lod” shows up. Press [SET] to enter the setting. Press [UP] or [DOWN] to toggle between the air temp “P1”, or the sample temp “P3”. Press [SET] once to confirm the new setting. The display will now show the temp you have selected.



We strongly recommend you to change the “Lod” setting back to “P3” before you complete the service. This will allow users to see the sample-simulated temperature, and the controller will be able to alert when the sample temp is out of range.

Calibration / offset

“OT” setting allows you to change the air probe’s calibration. “O3” setting allows you to change the sample probe’s calibration.

Please be sure you have a NIST traceable and calibrated thermometer. Place your thermometer’s probe next to our sensor accordingly, air vs. air, or sample vs. sample, before making an adjustment on either “OT” or “O3”.

For more advanced settings, please contact our Technical Service Department for assistance. (800) 648 4041 Option 4

VERSION TWO



Control Sequence of Operation

WE RECOMMEND THAT ONLY THE SET-POINT AND/OR DEFROST INTERVAL MAY BE ADJUSTED DUE TO CERTAIN CONDITIONS.

LAE Electronic Control



LAE Control Icons

- Compressor Running
- Evaporator Fan Running
- Cabinet in Defrost
- Activation of 2nd Parameter Set - NA
- Alarm - NA



Info/Set Point Button



Manual Defrost/Down Button



Manual Activation/Up Button



Stand-By Button



DISPLAY	
<i>dEF</i>	Defrost in progress
<i>oFF</i>	Controller in stand-by
<i>do</i>	Door open alarm
<i>Et 1</i>	Instant probe 1 temperature
<i>Et 2</i>	Instant probe 2 temperature
<i>Et 3</i>	Instant probe 3 temperature
<i>ñ m</i>	Minutes of the Real Time Clock
<i>hr 5</i>	Hours of the Real Time Clock
<i>h1</i>	Room high temperature alarm
<i>Lo</i>	Room low temperature alarm
<i>E 1</i>	Probe T1 failure
<i>E 2</i>	Probe T2 failure
<i>E 3</i>	Probe T3 failure
<i>Et h 1</i>	Maximum probe 1 temperature recorded
<i>Et Lo</i>	Minimum probe 1 temperature recorded
<i>Loc</i>	Keypad state lock

LOCKING AND UNLOCKING LAE CONTROLLER

HOW:

- A.** To change lock setting press and release the info button . “t1” will appear. See image 1.

Press the up button  until “Loc” appears.
See image 2.

- B.** While pressing and holding the info button  press the up  or down  button to change the lock settings. If “no” appears, the controller is unlocked. If “yes” appears, the controller is locked. See images 3 and 4.

- C.** Once the lock setting has been set correctly release the info button .

Wait 5 seconds for the display to show temperature.
See image 5.



Image 3:
If “no” appears
on screen,
the controller
is unlocked.







Image 4:
If “yes” appears
on screen,
the controller
is locked.



HOW TO CHANGE THE “SET POINT”

HOW:

- A.** To see the set point, press and hold the info button. See image 1.
- B.** While still holding the info button , press the up  or down  button to change the “set point”.
- C.** Once the “set point” has been set correctly release the info button .
The display will show temperature. See image 2.



Quick Troubleshooting Guide

Check these items before calling for service

PROBLEM:	POSSIBLE CAUSE / SOLUTIONS:
Unit does not run	<ul style="list-style-type: none"> • Electrical circuit is not 110-120V 60Hz. • The power cord is not plugged in. • No power at electrical outlet. Check to make sure breaker is not tripped or fuse is not blown. Additionally, make sure unit is not plugged into a Ground Fault Circuit Interrupter (GFCI) type of outlet.
Unit does not maintain at the proper temperature	<ul style="list-style-type: none"> • Check the room temperature. We recommend the refrigerator or freezer should be placed in an air conditioned room between 65°F to 85°F. If the room temp is too warm, the refrigerator or freezer may not be able to maintain the interior temp at proper range. • Door is not closed properly. • Amount of stored product is overloaded. • Product replacements are pushed against rear wall or interrupted the proper refrigerator air circulation. For the proper air circulation, place the products evenly on each shelf. Do not push against the refrigerator's rear or side walls. • Evaporator is blocked by frost or ice. Remove the products, unplug the refrigerator or freezer power, and allow the unit to defrost. If the problem still exists, call for service. • 3rd party thermometer is placed incorrectly. For proper temperature monitoring, the thermometer should be placed in the middle of refrigerator. <p>PLEASE NOTE! Prior to shipment, each refrigerator and freezer has been calibrated and tested at proper temperature range.</p>

Appliance runs too long	<ul style="list-style-type: none"> • Prolong door openings. • Control set too cold. • Room temperature is high which will make the unit work harder to keep cool.
Temperature of external wall surface is warm	<ul style="list-style-type: none"> • The exterior walls can be as much as 30 degrees warmer than room temperature due to the embedded condenser coils. This is normal when the unit is operating.
Compressor noises	<ul style="list-style-type: none"> • Compressor may be overheated. Please check the room temp and ensure the range is within 65°F to 85°F. If the problem still exists, call for service.
Moisture collects inside	<ul style="list-style-type: none"> • Door gasket is not sealing properly. Check for debris, cracks, and items passing through door at the gasket. • The refrigerator or freezer is facing a doorway or is underneath of air conditioning vent. Relocate the unit or redirect air vent. • Too many door openings. Minimize time door is open. • Hot, humid weather increases condensation. • Make sure there is a water trap (U-shaped loop) in the drain tube near the compressor. This will “trap” a small amount of water in the loop and prevent air from entering the chamber through the tube.
Moisture collects on outside surface	<ul style="list-style-type: none"> • Hot, humid weather increases condensation. • As humidity decreases, moisture will disappear.
Odor inside the unit	<ul style="list-style-type: none"> • Interior needs to be cleaned. See section on maintenance and cleaning in this manual. • Make sure product containers are tightly sealed to prevent leakage
Door will not close	<ul style="list-style-type: none"> • The unit is not level. Refer to the Leveling section at the beginning of this manual • Check for dirt and debris or items passing through the door seal.

MOISTURE DURING THE SUMMER SEASON

The amount of moisture, condensation, or high humidity related issues increase during the summer and, in most cases, will self-resolve when the weather cools down. Please note a refrigeration system will NOT generate moisture or water but simply condenses the moisture that is already in the chamber. Keeping the unit in an

air conditioned, low humidity space will resolve many issues. Other things you should check

1. Location of the refrigerator (See Quick Troubleshooting Guide above)
2. Door sealing and frequency of door opening event (See Quick Troubleshooting Guide above)
3. Make sure there is a water trap (U-shaped loop) in the drain tube near the end. This will “trap” a small amount of water in the loop and prevent air from entering the chamber through the tube.

BEFORE CALLING THE MANUFACTURER’S TECHNICAL SUPPORT DEPARTMENT, please have the unit’s model and serial number ready as well as the problem description. The model and serial number is located on the serial tag which can be found on the interior left upper wall of the unit.

CLEANING

PART	CLEANING AGENTS	TIPS AND PRECAUTIONS
Interior and Door Liners	Soap and water Baking soda and water	Use 2 tablespoons of baking soda in 1 quart of warm water Be sure to wring excess water out of sponge or cloth before cleaning around controls, light bulb or any electrical parts.
Door Gaskets	Soap and water	Wipe gaskets and their seating surfaces with a clean soft cloth
Shelves	Soap and water	Do not wash removable shelves in dishwasher
Exterior and Handles	Soap and water Non Abrasive Glass Cleaner	Do not use commercial household cleaners, ammonia, or alcohol to clean handles Use a soft cloth to clean smooth handles Do not use a dry cloth to clean smooth handles

Clean the glass with a mild detergent and water on a soft cloth or sponge. Rinse with water and wipe dry.

For Sliding door units, dust and debris can begin to build up in the door track. To clean the door track the doors should be removed and the track cleaned with mild detergent and water on a soft cloth or sponge. Rinse with clean water and wipe dry. Contact technical support if you have difficulty removing the doors.

For Swinging door units, pay particular attention to the gasket and its seating surfaces. Any debris buildup on these can cause air leaks into the compartment resulting in condensation as well as reduced efficiency.

CONDENSER MAINTENANCE

IMPORTANT WARRANTY INFORMATION

Air is pulled through the condenser continuously during operation. Along with this air come impurities like dust, lint, grease, etc.

These impurities accumulate in the condenser. Dirty condensers result in inefficient operation, compressor failure and potential product loss **which are not covered by warranty**.

If you keep the condenser clean, you will minimize your service expense and lower your electrical costs. **The condenser requires scheduled cleaning every 30 day** (or more frequently in dirty environments).

Proper cleaning involves removing dust from the condenser. This can be accomplished using a soft brush, by vacuuming, and by blowing through the condenser coils with pressurized air, CO₂, or nitrogen.

- **REMEMBER, THE CLEANING OF THE CONDENSER IS NOT COVERED BY THE WARRANTY AND IS YOUR RESPONSIBILITY. ANY DAMAGE CAUSED BY FAILURE TO KEEP THE CONDENSER CLEAN IS ALSO NOT COVERED BY THE WARRANTY.**

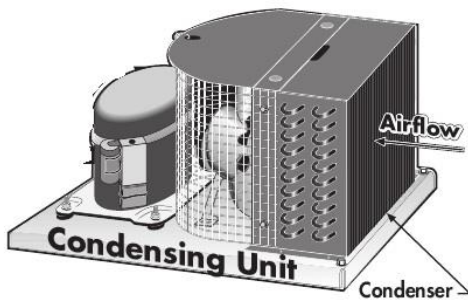

CLEANING THE CONDENSER

1. Disconnect the electrical power to the unit
2. Removed the louvered grill at the base of the unit. Locate the condensing unit.
3. **CAUTION: Use eye protection while performing the steps 4-6 to avoid eye injury.**

4. Vacuum the dirt from the condenser coil fins. Use a soft brush to help dislodge the dirt from the coil fins and around the coil ends.
5. When properly cleaned, you should be able to see through the condenser unit (try shining a flashlight through to the other side).
6. If necessary, use compressed air, CO₂ or Nitrogen to blow through the coils. Limit air pressure to approx. 30 psi.
7. When finished, be sure to replace the louvered grill as it provides protection for the condenser.
8. Reconnect the electrical power to the unit.

Hydrocarbon Service Notes

According to U.S. Code of Federal Regulation 40 Part 82, this refrigerator employs the natural refrigerant, specifically hydrocarbon, R290 or R600a.

Because of the nature of hydrocarbon refrigerant, for mechanical repair, such as recharge the refrigerant, or compressor replacement, should only be carried out by a certified refrigeration technician.

The safety of this equipment is listed by Underwriter Laboratory (UL) under Standard 471, Section SB – “natural refrigerant”.

Factory Warranty Policy

Horizon Scientific, Inc. warrants to the original purchaser every new Horizon Scientific, Inc. refrigerated unit, the cabinet and all parts thereof, to be free from defects in material or workmanship, when such unit is installed, used, and maintained in accordance with provided instructions. The warranty period starts two weeks from the date of shipment from Horizon Scientific, Inc. This two week period allows ample shipping time so that the warranty will go into effect at approximately the same time your equipment is delivered. Unless subject to prior written agreement with Horizon Scientific, Inc., this warranty does not allow for any warranty start deferment greater than two weeks from date of shipment due to a delayed installation and/or start-up. By purchasing any product from Horizon Scientific, Inc., you and any entity for which you are purchasing acknowledge and agree to each and every provision contained herein, and all other Notices and Terms provided to Purchaser by Horizon Scientific, Inc., which are hereby incorporated.

Under this warranty, Horizon Scientific, Inc., through its authorized service organizations, will repair, or at its option, replace any part found to contain a manufacturing defect in material or workmanship without charge to the owner for parts and service labor. Replacement or repaired parts will be warranted for only the unexpired portion of the original warranty. Horizon Scientific, Inc. will not assume any shipping or cartage costs for parts under warranty. These costs shall be paid by the customer.

ADDITIONAL COMPRESSOR WARRANTY

In addition to the standard warranty, Horizon Scientific, Inc. warrants its hermetically and semi-hermetically sealed compressors to be free from defects in both material and workmanship under normal use and service in addition to the standard warranty period. Compressors determined by Horizon Scientific, Inc. to have been defective within this extended time period will, at Horizon Scientific, Inc.'s option, be either repaired or replaced with a compressor or compressor parts of similar design and capacity.

The compressor warranty applies only to hermetically and semi-hermetically sealed parts of the compressor and does not apply to any other parts or components, including, but not limited to, cabinet, paint finish, temperature control, refrigerant, metering device, driers, motor starting equipment, fan assembly or any other electrical components.

Horizon Scientific, Inc.'s sole obligation under this warranty is limited to either repair or replacement of parts, subject to the additional limitations below. This warranty neither assumes nor authorizes any person to assume obligations other than expressly covered by this warranty.

NO CONSEQUENTIAL DAMAGES. Horizon Scientific, Inc. is not responsible for economic loss; profit loss; or special, indirect or consequential damages, including

without limitation, losses or damages arising from contents spoilage claims whether or not on account of refrigeration failure, electrical failure, power failure, or compressor failure. HORIZON SCIENTIFIC, INC.'S MAXIMUM CUMULATIVE LIABILITY RELATIVE TO ALL CLAIMS AND LIABILITIES, INCLUDING OBLIGATIONS UNDER ANY INDEMNITY, WHETHER OR NOT INSURED, SHALL NOT EXCEED THE COST OF THE PRODUCT(S) GIVING RISE TO THE CLAIM OR LIABILITY.

WARRANTY IS NOT TRANSFERABLE. This warranty is not assignable and applies only in favor of the original purchaser/user to whom delivered. Any such assignment or transfer shall void the warranties herein made and shall void all warranties, express or implied, including any warranty of merchantability of fitness for a particular purpose.

NO IMPLIED WARRANTY OF MERCHANTABILITY OF FITNESS FOR A PARTICULAR PURPOSE. There are no other warranties, express, implied, or statutory, except the standard warranty and the additional compressor warranty as described above. These warranties are exclusive and in lieu of all other warranties, including implied warranty and merchantability of fitness for a particular purpose. There are no warranties which extend beyond the description on the face hereof, whether based on contract, warranty, tort (including negligence), strict liability, indemnity, or any other legal theory, and whether arising out of warranties, representations, instructions, installations, or non-conformities from any cause. Purchaser further acknowledges that the purchase price of the Product reflects these warranty terms and remedies.

ALTERATION, NEGLIGENCE, ABUSE, MISUSE, ACCIDENT, DAMAGE DURING TRANSIT OR INSTALLATION, FIRE, FLOOD OR OTHER EXTERNAL CAUSES.

Horizon Scientific, Inc. is not responsible for the repair or replacement of any parts that Horizon Scientific, Inc. determines have been subjected after the date of manufacture to alteration, neglect, abuse, misuse, accident, damage during transit or installation, fire, flood or other external causes. It does not apply to defects resulting from failure to properly install, operate or maintain the product in accordance with the printed instructions provided, or damage caused by the storage of any corrosive material that comes in contact with the interior or exterior portions of the cabinet, or the use of spark producing equipment or containers (such as galvanized or carbonized steel containers) that come in contact with any interior portion of the cabinet.

OUTSIDE U.S./CANADA. This warranty does not apply to, and Horizon Scientific, Inc. is not responsible for, any warranty claims made on products sold or used outside the United States and Canada.

CHOICE OF LAW/VENUE. The laws of the State of South Carolina shall govern the validity, interpretation and enforcement of this warranty, regardless of conflicts of law principles. Purchaser agrees that proper venue for any action to enforce the terms of this warranty shall be the Dorchester County District Courts, South Carolina. Purchaser submits the jurisdiction of such courts over the Purchaser and the subject matter of

any such action. Any action for breach of these warranty provisions must be commenced within one (1) year after that cause of action has accrued.

WARRANTY CLAIMS. To obtain prompt warranty service, simply contact the manufacturer at 800-648-4041. Horizon Scientific, Inc.'s shipping records showing date of shipment shall be conclusive in establishing the warranty period. All claims should include: model number of the refrigerator, the serial number of the cabinet, proof of purchase, date of installation, and all pertinent information supporting the existence of the alleged defect. Any repairs must be authorized by Horizon in order for the warranty to be honored.